

*Inspired  
by Water*

**WELLNESS**





# Wellness

## Steam and Sauna from **helo**

### *Simplicity is a Good Thing*

We have trail-blazed the sauna industry for almost one hundred years. The time has come to introduce the only multilayered sauna experience on the market. A new dimension in modern sauna solutions. A new dawn in sauna engineering. Try the new BWT, Bio Water Technique from Helo.

## Atecpool Spa Royal Collection

### *The key to Wellness*

Based on our 30 years experience in the creation of modern swimming pool techniques and the whirlpool equipment, as the expert on the European market, it is our pleasure to present our newest collection of highly advanced portable spas and In-ground spas.



# TyloHelo

## Sauna Rooms

### TyloHelo Sauna



**TyloHelo**  
Sauna Rooms



**Corner**  
Aspen



**Corner with glazed section**  
Aspen



**Square**  
Alder



**Square with glazed section front**  
Alder



**Square with glazed section side**  
Aspen



**Square with glazed section front & side**  
Aspen



**Glass front**  
Alder



**Glass corner**  
Aspen



**Square with round glass corner**  
Aspen

# TyloHelo

## Sauna Rooms

### TyloHelo Premium Saunas for well-being

When you step in to the sauna room you leave the rest of the world outside. The moment is yours. The complete sensation is affected by light, smell, sound and the feel of the surrounding room. Helo quality is evident by our styling and design - where small details help create the ideal sauna ambience. A soft rounded back support with integral fibre optic lighting and a curved seat gives a relaxed comfort. Beautiful materials in walls and doors create harmony and well-being.

We only use the highest quality, hand-selected wood for our sauna rooms and interiors. To us the need for quality is obvious. Our products are a part of your lifestyle and must therefore withstand regular use for many years.



#### 1. Layout

Choose between square, corner, glass front, glass corner and round corner.

#### 2. Panel

Horizontal or vertical paneling available in four different types of wood: Spruce, Aspen, Thermo-Aspen or Hemlock. Or two kinds of solid log: Spruce or Fir.

#### 3. Interior

Choose between Classic, Classic slim, wide benches made of Alder or Aspen. Then select a closed style with skirting panel or an open style without skirting panel. The skirting can have either soft or straight bench front.

#### 4. Glass

You can choose between clear glass, tinted glass or frosted glass.

#### 5. Door Handle

Choose between horizontal and vertical orientation or go for the design handle.

#### 6. Soffit

Soffits come with built-in lighting.

#### 7. Heater

Here it is important to know the size of the sauna to select the correct model.

### Choose your wood for Helo Saunas - Spruce, Aspen, Hemlock and more



Aspen



Alder



Hemlock



Pine



Premium Log Spruce

# TyloHelo

## Sauna Rooms

### TyloHelo Premium Saunas Interior Styling

Harmony interiors are available in a number of different designs and are made to match the style of your Harmony. Your sauna room can be designed to custom standards by choosing from several types of wood and designs.

#### Classic

The Classic range of solid Aspen, Alderwood or Thermo Alder sauna interior is available in pre-cut measurements or may be cut to individual preferences. The range includes benches and back rests with available skirting and siding for a complete and finished look.



#### Classic Slim

Classic Slim sauna interiors in Aspen, Alderwood or Thermo Alder are available in pre-cut measurements but may be cut to individual requirements for custom builds. The range includes benches and back rests with available skirting and siding for a complete and finished look.

#### Classic Wide

The Classic Wide range of American Tulip, Aspen, Alder or Thermo Alderwood. The sauna interior is available in custom measurements as flex interior. The range includes benches and back rests.



#### Panorama Interior

The Panorama range of sauna benches with the overlapping design are made of Aspen, Alder and Thermo Alder and are available in custom measurements as flex interior.

# TyloHelo

Sauna rooms



# TyloHelo

## Sauna Heaters

### Soft Sauna. Lower temperature, higher humidity

Stay longer in the sauna. Lower the temperature and immerse yourself in warm steam. Keep the room temperature at a mild 45-65 °C and increase humidity to 30-65% to create that perfect soft sauna climate. This sauna therapy is perfect for families and friends.



### TyloHelo Saunas

This sauna therapy is perfect for families and friends.



#### Sense Combi Elite

Gives a quicker heat up time and lets you set the exact percentage of humidity for full control. Local Wifi connectivity for maximum advantage and comfort is included.



#### Sense Combi Pure

Comes with the standard digital touch control panel for ease of use and convenience. Let you set temperature and time.

#### Sense Elite/Pure Specifications

- 6.6 kW - for sauna volume 4-8 m<sup>3</sup>
- 8 kW - for sauna volume 6-12 m<sup>3</sup>
- 10.5 kW - sauna volume 10-18 m<sup>3</sup>
- Offers both dry, wet and steam sauna (Soft Sauna).
- Choose either control panel Elite or Pure for your Combi heater. The control panel is included in the price.



#### Sense Sport 2/4

- 2.2 kW - for sauna volume 2-2.5 m<sup>3</sup>
- 4.5 kW - for sauna volume 2-4 m<sup>3</sup>
- Offers a classic dry sauna.
- Has a built-in control panel.
- Suitable for domestic use.



#### Sense Sport Combi 4

- 4.5 kW - for sauna volume 2-4 m<sup>3</sup>
- Offers both dry, wet and steam sauna (Soft Sauna).
- Has a built-in control panel
- Suitable for domestic use.



#### Sense Sport

- 6.6 kW - for sauna volume 4-8 m<sup>3</sup>
- 8 kW - for sauna volume 6-12 m<sup>3</sup>
- Offers a classic dry sauna.
- Control panel with thermostat and mechanical timer integrated into the base of the heater.
- Suitable for domestic use.

# TyloHelo

## Sauna Heaters

### Soft Sauna. Lower temperature, higher humidity

Stay longer in the sauna. Lower the temperature and immerse yourself in warm steam. Keep the room temperature at a mild 45-65 °C and increase humidity to 30-65% to create that perfect soft sauna climate.



### TyloHelo Saunas

This sauna therapy is perfect for families and friends.



### Sense Commercial

- 6.6 kW - For sauna volume 4-8 m<sup>3</sup>
- 8 kW - For sauna volume 6-12 m<sup>3</sup>
- 10.7 kW - For sauna volume 10-18 m<sup>3</sup>
- 16 kW - For sauna volume 15-35 m<sup>3</sup>
- 20 kW - For sauna volume 22-43 m<sup>3</sup>
- Offers a classic dry sauna in public settings.
- Add control panel Elite together with relay box Commercial / Commercial Lite.
- Suitable for commercial use



### Expression

- 10 kW for sauna volume 10-18 m<sup>3</sup>
- Offers a classic dry sauna.
- Add control panel Elite or Pure with Relay Box Commercial Lite.
- Suitable for domestic and commercial use.

### Expression Combi

- 10 kW - For sauna volume 10-18 m<sup>3</sup>.
- Offers both dry, wet and steam sauna (Soft Sauna).
- H2 control panel and relay box RB45 are included in the price.
- Suitable for domestic and commercial use.



Available colours:



Copper



Champagne



Black



Black Thermosafe



# TyloHelo

## Sauna Heaters - buying guide

### Home electric sauna heaters

Model	Code	Output	Sauna volume	Min. distance to side wall	Min. ceiling height	Suitable control panel	Weight heater + rocks	Height	Width	Depth	Installation
		kW	m <sup>3</sup>	mm	mm		kg	mm	mm	mm	
Sense Sport 2/4	62202020	2.2-4.5	2-4	20	1900	Built-in	9.3+7	480	348	214	Wall mounted
Sense Sport Combi 4	62202060	4.5	2-4	20	1900	Built-in	13.4+7	490	348	274	Wall mounted
Sense Sport 6	61001330	6.6	4-8	110	1900	Built-in	17+20	559	431	375	Wall mounted or floor standing*
Sense Sport 8	61001332	8	6-12	110	1900	Built-in	17+20	559	431	375	Wall mounted or floor standing*
Sense Pure 6	61001344	6.6	4-8	110	1900	Pure included	17+20	559	431	375	Wall mounted or floor standing*
Sense Pure 8	61001346	8	6-12	110	1900	Pure included	17+20	559	431	375	Wall mounted or floor standing*
Sense Pure 10	61001348	10.5	10-18	110	1900	Pure included	17+20	559	431	375	Wall mounted or floor standing*
Sense Elite 6	61001338	6.6	4-8	110	1900	Elite included	17+20	559	431	375	Wall mounted or floor standing*
Sense Elite 8	61001340	8	6-12	110	1900	Elite included	17+20	559	431	375	Wall mounted or floor standing*
Sense Elite 10	61001342	10.5	10-18	110	1900	Elite included	17+20	559	431	375	Wall mounted or floor standing*
Sense Combi Pure 6	61001356	6.6	4-8	110	1900	Pure included	23+20	559	431	375	Wall mounted or floor standing*
Sense Combi Pure 8	61001358	8	6-12	110	1900	Pure included	23+20	559	431	375	Wall mounted or floor standing*
Sense Combi Pure 10	61001360	10.5	10-18	110	1900	Pure included	23+20	559	431	375	Wall mounted or floor standing*
Sense Combi Elite 6	61001350	6.6	4-8	110	1900	Elite included	23+20	559	431	375	Wall mounted or floor standing*
Sense Combi Elite 8	61001352	8	6-12	110	1900	Elite included	23+20	559	431	375	Wall mounted or floor standing*
Sense Combi Elite 10	61001354	10.5	10-18	110	1900	Elite included	23+20	559	431	375	Wall mounted or floor standing*
Expression 10 Black	61001000	10	10-18	200	1900	Pure or Elite with relay box Commercial Lite	29+12	730	500	200	Floor standing*
Expression 10 Champagne	61001003	10	10-18	200	1900	Pure or Elite with relay box Commercial Lite	29+12	730	500	200	Floor standing*
Expression 10 Copper	61001006	10	10-18	200	1900	Pure or Elite with relay box Commercial Lite	29+12	730	500	200	Floor standing*
Expression 10 Black Thermosafe	61001120	10	10-18	200	1900	Pure or Elite with relay box Commercial Lite	29+12	730	500	200	Floor standing*

### Professional electric sauna heaters

Model	Code	Output	Sauna volume	Min. distance to side wall	Min. ceiling height	Suitable control panel	Weight heater + rocks	Height	Width	Depth	Installation
		kW	m <sup>3</sup>	mm	mm		kg	mm	mm	mm	
Sense Commercial 6	61001334	6.6	4-8	110	1900	Pure or Elite with relay box Commercial Lite	16+20	559	431	375	Wall mounted or floor standing*
Sense Commercial 8	61001336	8	6-12	110	1900	Pure or Elite with relay box Commercial Lite	16.5+20	559	431	375	Wall mounted or floor standing*
Sense Commercial 10	61001090	10.7	10-18	150	1900	Pure or Elite with relay box Commercial Lite	32+25	650	650	400	Wall mounted
Sense Commercial 16 3x400V	61001092	16	15-35	150	2100	Pure or Elite with relay box Commercial	32+25	650	650	400	Wall mounted
Sense Commercial 20 3x400V	61001094	20	22-43	150	2100	Pure or Elite with relay box Commercial	32+25	650	650	400	Wall mounted

\* Feet for floor standing need to be bought separately.

### Relay Box Commercial Lite/Commercial

Relay Box Commercial Lite is designed for control together with the control panels Elite or Pure and is suitable for sauna heaters Expression and Sense Commercial up to 10.7kW. Relay Box Commercial for heater capacities 16-20kW

Code	Description
71016014	Relay box Commercial Lite
71016012	Relay box Commercial



# TyloHelo

## Sauna Heaters



### Helo Cup Sauna Heater

Reliable and safe Cup sauna heaters are an excellent choice for traditional Finnish type sauna. These compact wall mounted heaters are designed for domestic small and mid-size sauna rooms. They are easy to assemble and easy to use with builtin timer and thermostat or with separate control unit. With the timer you can pre-select the time when you want the heater to be turned on, max. 9 hours beforehand. The running time is max 3 hours. CUP D require separate control unit while CUP STJ heater comes with built-in thermostat and a timer 9+3 hrs.

Code	Power	Sauna size	Dimensions (mm)			Stones	Mounting	Safety distances (mm)				
	kW	m <sup>3</sup>	W	H	D			kg	Side	Front	Behind	Ceiling
CUP 45 D	4.5	3 - 6	410	580	280	15	Wall	50	80	-	1200	120
CUP 60 D	6.0	5 - 9	410	580	280	23	Wall	70	100	-	1250	120
CUP 80 D	8.0	8 - 13	410	580	300	23	Wall	100	150	-	1250	120

Control Unit for CUP D heater : Elite or Pure Control with relay box (WE40)



### Helo SKLE Professional Electric Heater

SKLE are suitable for saunas sized from 8 - 46 m<sup>3</sup>. Designed for commercial sauna rooms, Helo SKLE heaters are robust, easy to maintain and their 60 kg of stones create an attractively soothing sauna climate. Helo SKLE is used with separate control panel.

Code	Power	Sauna size	Dimensions (mm)			Stones	Mounting	Safety distances (mm)				
	kW	m <sup>3</sup>	W	H	D			kg	Side	Front	Behind	Ceiling
SKLE 1051	10.5	9 - 15	510	700	475	60	Floor	140	160	160	1400	-
SKLE 1201	12	10 - 18	510	700	475	60	Floor	140	160	160	1400	-
SKLE 1501	15	14 - 24	510	700	475	60	Floor	140	160	160	1500	-

Control Unit for SKLE heater : Elite or Pure Control with relay box (WE40)



### Helo SKLA Professional Electric Heater

The heater is freestanding and available in a variety of models to suit different business needs. Helo SKLA is specially engineered for larger commercial saunas that require durable, powerful and cost-efficient heaters - without compromising on the rich steam and soothing sauna atmosphere. The Helo SKLA heaters accommodate 120 kg of rocks, ensuring a genuinely ideal sauna climate for guests.

Code	Power	Sauna size	Dimensions (mm)			Stones	Mounting	Safety distances (mm)				
	kW	m <sup>3</sup>	W	H	D			kg	Side	Front	Behind	Ceiling
SKLA 181	18	18 - 30	880	700	510	120	Floor	80	80	110	1200	-
SKLA 210	21	24 - 36	880	700	510	120	Floor	80	80	110	1200	-
SKLA 260	26	30 - 46	880	700	510	120	Floor	120	120	120	1400	-

Control Unit for SKLA heater : Elite or Pure Control with relay box (WE50)



# TyloHelo

## Sauna Accessories

### TyloHelo Sauna Accessories



#### Heater guard

Wall mounted heater guard

6.6-8 kW. Code: 90001002

10.7-20 kW. Code: 90001012

#### Ventilation Hatch B

Fits over the air outlet inside the sauna to regulate air flow.  
Size: 14 x 37,5 cm.  
Code: 90181036



#### Ventilation Grille B

Size: 14x22 cm.  
Code: 90181040



#### Sauna Wood -Treatment Oil

For treating benches and other wood surfaces in the sauna. Covers approx. 6m<sup>2</sup>. Code: 90022050



#### Fixed Headrest

Headrest made of narrow wooden slats.  
Size: 37,5x27x8cm.  
Alder: code 90081016  
Aspen: code 90081014



#### Adjustable Sauna Headrest

Height adjustable.  
Size: 42,5x37,5x7cm.  
Alder: code 90081012  
Aspen: code 90081010



#### Strip package

Contains three strips of light aspen, measuring 12 x 43 x 2400 mm. Suitable as a door lining, internal or external ceiling strip, etc. Code: 91031575



#### Threshold

Suitable for DGB and DGL doors with door widths 7 and 8. Size: 30 x 92 mm.

DGL/DGB width 7 Pine. Code 91031560

DGL width 7 Aspen. Code 91031561

Broad DGB width 8 Pine. Code 91031565

DGL width 8 Aspen. Code 91031566

#### Foot for Sense

Foot for all Sense sauna heaters. Color black.  
Sense 6/8/10. Code: 90001060  
Sense Combi 6/8/10. Code: 90001061



#### Steam distributor commercial

The Tylo Steam Distributor Commercial improves the distribution of steam in your sauna room. Specially designed for the sauna heater Sense Commercial 10-20kW.

Code: 90029263



# TyloHelo

## Sauna Accessories

### TyloHelo Sauna Accessories



Add a fragrance to your sauna to stimulate your senses. Peppermint and citrus pick your moods up, eucalyptus is refreshing and helps against colds, lavender has a relaxing effect.



#### Essential Oils

100% essential oils. Release invigorating scents in your sauna. 10 ml/bottle.

Eucalyptus: Code: 90024080

Peppermint: Code: 90024084

Lavender: Code: 90024082

Citrus: Code: 90024086

Fragrance Collection, 4-PACK 10 ml/bottle.  
Code: 90024100



#### Concentrated Fragrances

For earlier models of Tylo Sauna Fresh and Stream Fresh. 250 ml/bottle.

Eukaliptus: code 90024060

Peppermint: code 90024064

Lavender: 90024062

Citrus: 90024066



#### Essential Oils

Concentrate of natural fragrances specially produced for our Tylo Fresh fragrance dispenser for saunas and steam baths. 250 ml/bottle.

Eucalyptus: Code: 90024040

Peppermint: Code: 90024044

Lavender: Code: 90024042

Citrus: Code: 90024046



#### Helo Sauna Stones

Natural Vulcanite stones that provides excellent heat radiation.

Vulcanite sauna stones - top quality, approved Finnish sauna stones that are durable and provide excellent heat radiation. Although the stones have been washed, we recommend you rinse them again with water before placing them in the sauna heater. Locate the stones loosely around the elements. This will improve the sauna heating time and prolong element life. 50 packages fits on one pallet.

Helo Sauna stones 20 Kg small size for wall heaters. Code: 0043020

Helo Sauna stones 20 kg big size for floor heaters. Code: 0043022

# TyloHelo

## Sauna Accessories



### Dark Accessories

**Hygrometer** Code: 90152778

**Bucket** Code: 90152772

**Ladle** Code: 90152774



### Premium Pro

These are products to choose if you have a professional sauna or just want really high quality products that last.



### Pro Accessories

Stainless Steel Accessories

**Bucket pro** Code: 90041060

**Hygrometer/Thermometer pro**  
Code: 90041062



### Shower Barrel

10-litre shower barrel with automatic water refill for a refreshing cool-down after your sauna.

Height with chain: 630 mm.

Code: 90029050

### Classic

Light wood.



### Classic Accessories

Wooden Sauna Accessories

**Bucket** (Pine,4L) Code: 0038815

**Ladle** Code: 90121022

**Hygrometer/Thermometer** Code: 90152813

**Thermometer** Code: 90152823

### Black Accessories

Tylö Brilliant Hygrometer / Thermometer Black. Made from aluminium which is sand-blasted and anodised.

**Hygrometer.** Code: 90152420

**Thermometer.** Code: 90152430



### Silver Accessories

Tylö Brilliant Hygrometer / Thermometer Silver. Made from aluminium which is sand-blasted and anodised.

**Hygrometer.** Code: 90152422

**Thermometer.** Code: 90152432



# TyloHelo

## Sauna Accessories

### Doors for Sauna Rooms

All sauna doors offered by Helo are produced following all safety regulations and customers expectations. Thermo treated glass is been used in production, which is five times stronger than the usual glass. In order to avoid bending of the jambs due to fluctuation of temperature, all the jambs are made of knot-free glue-laminated birch or alder. Doors can be mounted left or right hinged. Robust pine door with tempered 8mm safety glass.

Code	Description	Dimension
		mm
91031510	<b>Sauna Glass Door W / Alder Frame 80 x 190</b> Bronzed glass door, width of opening 760 mm, no threshold.	800 X 1900
91031916	<b>Sauna Glass Door W / Alder Frame 90 x 190</b> Bronzed / Clear glass door, width of opening 860 mm, no threshold.	900 X 1900
91031920	<b>Sauna Glass Door W / Pine Frame 90 x 200</b> Bronzed / Clear glass door, width of opening 860 mm, no threshold.	900 X 2000
91031924	<b>Sauna Glass Door W / Pine Frame 90 x 210</b> Bronzed / Clear glass door, width of opening 860 mm, no threshold.	900 X 2100



# TyloHelo

## Sauna Accessories



### Loudspeakers

Steam and heat-resistant design.

**Speaker B For surface mounting.**

Size 230 x 145 mm, depth 165 mm. Code: 90803002

Supplied in pairs.

### External Switch 12V

On/off switch to control the sauna from locations other than where the control panel is installed.

Fits Elite and Pure.

Code: 90908048



### Door Contact

Prevents unintentional start-up of the sauna by remote control if the sauna door is open.

Code: 90908035



### Transformer LED 0-20W

200-240 V ~/12VDC. Max. load 20W. NB: The transformer must always be installed outside the sauna. Suitable for E90, E28 and LED light strip. LED transformer dimmable on the secondary side. Code: 90901030



### Transformer LED 6-18W

LED TRANSFORMER 230V~/ 18-52 VDC. Max. load 18 W. Dimmable. NB: The transformer must always be installed outside the sauna. Suitable for Tylo LED downlights. IP class 21. Code: 90901024



### Ruben Sky LED

The included control gives you a choice of seven pre-installed programmes or the option of creating your own programme with as many as 20 colour changes. Cable connections, 180mm mounting sleeves and electronic equipment are included. Can also be synchronised with lighting behind the backrest.

**Ruben Sky 20 Number: 20.**  
11.6 W output. Code: 90011072

**Ruben Sky 30 Number: 30.**  
17.4 W output. Code: 90011074

**Ruben Sky 40 Number: 40.**  
23.2 W output.  
Code: 90011076

**Ruben Sky 60 Number: 60.**  
34.8 W output.  
Code: 90011078



### RGB Lighting

Ready-made package containing LED strip RGB 2 x 1.91 m, transformer and remote control. Code: 90011360

# TyloHelo

## Sauna Accessories

### TyloHelo Sauna Accessories



#### Sauna LED Lighting

Includes lighting strips and transformer. Can be installed either inside or outside the sauna (not in the ceiling). Warm-white glow. Voltage 12 V. IP 54. Transformer LED 12 V DC 20 W.

**LED Length 1 x 500 mm. 2,4 Watt.** Code: 90011440

**LED Length 2 x 500 mm. 4,8 Watt.** Code: 90011442

**LED Length 3 x 500 mm. 7,2 Watt.** Code: 90011444

**LED Length 4 x 500 mm. 9,6 Watt.** Code: 90011446

**LED Length 5 x 500 mm. 12 Watt.** Code: 90011448



#### Sauna Lamp 40W

For wall mounting. White lamp holder E14. IP 55. Max 40 W. Diameter 90 mm, height 170 mm. Code: 90011000



#### LED Strip Light

Developed to allow for more subtle lighting effects. 12 V DC. Dimmable. Warm white 3000K.

**LED 38CM 12V/DC 0.16w**

Code: 90011350

**LED 50CM 12V/DC 0.25w**

Code: 90011352

**LED 90CM 12V/DC 0.50w**

Code: 90011354

**LED 190CM 12V/DC 1.20w**

Code: 90011356



#### Lighting Tube

Installed behind the backrest for pleasant, subdued lighting in sauna or steam room. Can be cut to size. 12 V. Connect to 12 V transformer. IP 65.

**Lighting tube 50 Length 50 cm. 15 W output.**

Code: 90011192

**Lighting tube 90 Length 90 cm. 27 W output.**

Code: 90011194

**Lighting tube 190 Length 190 cm. 57 W output.**

Code: 90011196



#### Sauna Led Lights

The set includes 12 LED lamps with silver heads, 4.5 metres of cable to each lamp, and the adapter. The colour of the lighting is warm white. The lighting has the property of directed emission with the scattering angle of 35. Code: 3815005-12

- 12pcs 5mm DIP LED
- 4.5m wire for each LED
- Connector with 12pcs holes
- Adapter with 12V,500mA, European plug
- 12pcs / set in a white box
- Cover color: Silver
- Lighting color: warm white
- Wattage 0.65W±10%
- Luminous 39.3lm±10%
- Cable working temp -20+85°C
- LED diode working temp -20+90°C
- Humidity 0-95%RH
- Input voltage AC/DC12V
- Life time: 50,000h
- Scattering angle of 35 degrees



#### Emergency Push Button

The emergency button allows to switch off the sauna heater via the overheating safety circuit. Isolation voltage AC/DC: 250 V Max current AC: 5 A Max current DC: 2,5 A. Code: 945777E



#### Opus 100 H175

Spotlight LED 6x0,45W. In brushed steel for recessed in the sauna ceiling. The kit is made of 6 luminaires with phase-divisible drive gear, extension cable and connecting cables. The drive unit is capable of powering and dimming 5-12 luminaires. Gives a warm light. (2700K)

Code: 90011080



#### LED Wall light

Soft light with a modern twist! G9 Maximum 25W, 230V, IP44. Diameter 98mm.

Code: 90011012





# TyloHelo Panacea

## Steam Bath

### Steam Room Panacea

The Panacea steam bath soothes both body and soul. The hot steam envelops the body, releasing tension and easing muscle aches, while a variety of light and sound settings provide relaxing additions to the mind. Panacea is available in 6 different standard sizes and comes with a dramatic back-lit wall. Choose between various glass tints and opaque options.



### Steamroom seating



#### Stool Corian 66

Ergonomic and easily portable stool.

Size: 660 x 310 x 450 mm (LxDxH).

Item no. 96075060

#### Stool Corian 35

Size: 350 x 320 x 420 mm (LxDxH).

Item no. 96075065

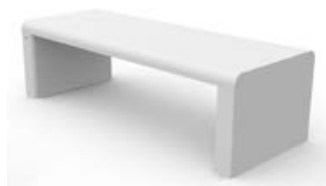

#### CORIAN BENCH

Hard-wearing and hygienic bench for larger steam rooms.

#### BENCH 1545

Size: 1545 x 600 x 450 mm (LxDxH).

Item no. 96075050

#### BENCH 1945

Size: 1945 x 600 x 450 mm (LxDxH).

Item no. 96075052

#### BENCH 2345

Size: 2345 x 600 x 450 mm (LxDxH).

Item no. 96075054



# TyloHelo Panacea

## Steam Bath

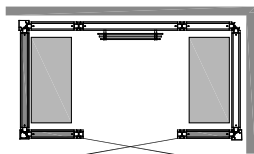

**PANACEA 1709**  
Size: 1725 x 925 x 2090 mm  
Code: 96075026

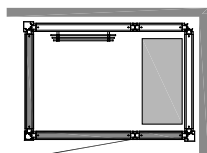

**PANACEA 1309 T**  
Size: 1325 x 925 x 2090 mm  
Code: 96075020

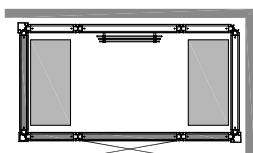

**PANACEA 1709 T**  
Size: 1725 x 925 x 2090 mm  
Code: 96075022

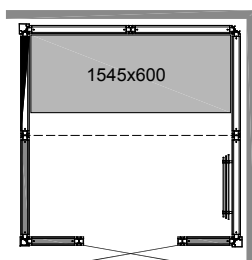

**PANACEA 1717 1B**  
Size: 1725 x 1725 x 2090 mm  
Code: 96075070

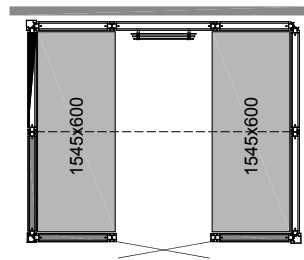

**PANACEA 2117 2B**  
Size: 2125 x 1725 x 2090 mm  
Code: 96075076

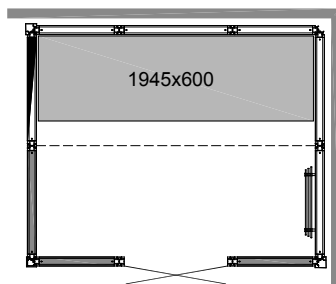

**PANACEA 2117 1B**  
Size: 2125 x 1725 x 2090 mm  
Code: 96075074

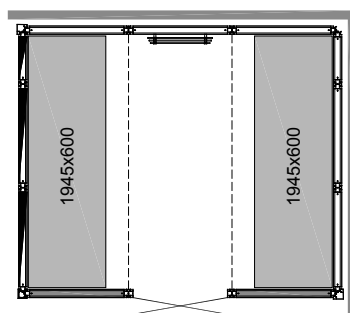

**PANACEA 2521 2B**  
Size: 2525 x 2125 x 2090 mm  
Code: 96075080

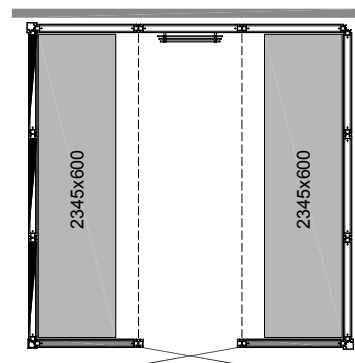

**PANACEA 2525 2B**  
Size: 2525 x 2525 x 2090 mm  
Code: 96075084

**Note:** 1717, 2117 and 2525 can be delivered with a handicap-friendly door (930 mm opening).

1309, 1709 is available with steam column or steam outlet and also with floor tray as option.

# TyloHelo Impression Twin

## Steam Bath



### Steam Room Impression Twin

Combined sauna and steam shower offering unique relaxation options. The design and materials exude a palpable feeling of luxury. The perfect way to relax after a workout session is to combine a sauna and steam shower. Impression Twin really gives you the best of both worlds. Walls, glass sections and doors can be assembled in a variety of ways to suit your bathroom layout. All interior fittings – except for the sauna heater – can be placed where you wish.



# TyloHelo

## Steam Generators

### TyloHelo Steam Generators

The steam delivery happens quickly and quietly through specifically developed steam nozzles. Have your steam room always ready to go at a moments notice through the convenience of stand-by mode.

TylöHelo has a strong tradition of providing steam generators for public and private use. Our latest series is fitted with a state-of-the-art control unit to ensure precise operation. Control the steam, lights, timer and other features at the simple touch of a button. Add fragrances and relax. Indulge yourself and all your senses.

### TyloHelo Steam Commercial and Steam Home

Super effective steam generators



#### Steam Home

Our latest compact and effective steam generator for home environments. It offers new and improved features such as stand-by, an aromatherapy option and improved protection against toppages.



#### Steam Commercial

Our Steam Commercial steam generator is equipped with a large water tank and is designed to easily connect to our Multi-Steam function - an effective way to avoid stoppages in frequently used systems.

### Steam Generators

Model	Code	Output	Steam room's min./max. volume (m3)				Steam production	Size (LxWxH)	Suitable control panel
			Light wall made of glass plastic, Elysé Excellent room, etc.		Heavy wall made of tiles, concrete, stone, etc.				
		kW	With ventilation	Without ventilation	With ventilation	Without ventilation	kg/h	mm	
Steam Home	66210120	3	-	max. 3	-	max. 2	3.5	480 x 350 x 159	Elite or Pure
		6	3-8	4-15	2-5	2.5-8	8		
		9	6-16	13-24	4-10	7-16	12		
Steam Commercial	66210010 66210015 66210020	9	6-16	13-24	4-10	7-16	12	585 x 415 x 230	Elite or Pure
		12	14-22	22-30	8-15	14-20	16		
		15	18-25	28-38	10-19	18-25	20		
2x9	66210010X2	18	20-30	28-40	13-20	18-30	24		Elite or Pure
2x12	66210015X2	24	28-40	38-50	18-30	28-40	32		
2x15	6210020x2	30	36-50	56-76	32-42	42-57	40		
3x9	66210010X3	27	38-45	46-60	28-40	38-52	36		Elite or Pure
3x12	66210015X3	36	43-60	58-70	38-50	48-60	48		
3x15	66210020x3	45	54-75	84-114	47-63	60-75	60		

# TyloHelo

## Steam Generators

### Helo Steam PRO

The new Helo Steam Pro generator automatically prevents overheating and dry running, should there be an interruption to the water supply. The generator saves time on maintenance and down time thanks to its automated filling function. For added convenience flushing and emptying functions are available, as well as the possibility to run several units through serial connection.



### Helo Steam Pro Specifications

- **Available sizes:**  
9.5 / 12 / 14 / 16 kW
- **Features:**  
Standby Function Automatic flush, Safety flush. Two aux outputs for fragrance/salt. Ganging with RJ connectors (1+2units). Resettable highlimit switch. New drain valve
- **Available Add-on:**  
Push button for activation from Standby

### Helo Steam

The Helo Steam generator for private use is based on the newest available technology. It sets a whole new level for user interface and reliability. It comes equipped with two auxiliary compartments for salt/fragrances for added comfort. It is also possible to order it with optional drain valve and automatic flush functionality.



### Helo Steam Specifications

- **Available sizes:**  
3.4 / 4.7 / 6 / 7.7 kW
- **Features:**  
Two aux outputs for fragrance/salt  
Resettable highlimit switch
- **Available Add-on:**  
Automatic flush  
New drain valve

### Steam Generators: Helo Steam & Steam Pro

Model	Code	Power	Steam production	Size (WxHxD)	Min/max volume steam room				Available color	Suitable control panel	Installation
					Thin wall of glass or plastic		Heavy wall of tile, concrete or stone				
					with ventilation	without ventilation	with ventilation	without ventilation			
		kW	kg/h	mm	m <sup>3</sup>						
Helo Steam 34	002100	3.4	5	636 x 380 x 164	2-6	2-7	2-4	2-5	Black	Elite or Pure	On the wall
Helo Steam 47	002101	4.7	6	636 x 380 x 164	3-7	3-8	2-5	2-6			
Helo Steam 60	002102	6	8	636 x 380 x 164	4-9	4-13	3-6	3-7			
Helo Steam 77	002103	7.7	10	636 x 380 x 164	6-11	6-15	4-8	5-9			
Helo Steam Pro 95	002104	9.5	13	636 x 380 x 164	9-13	9-17	6-9	7-11			
Helo Steam Pro 120	002105	12	16	636 x 380 x 164	11-18	12-24	8-12	9-16			
Helo Steam Pro 140	002106	14	19	636 x 380 x 164	14-22	18-30	10-14	11-17			
Helo Steam Pro 160	002107	16	21	636 x 380 x 164	17-25	23-35	12-16	12-18			

# TyloHelo

## Steam Accessories

### TyloHelo Steam Accessories

#### Water softener Premier Compact

Code: 90908027

#### Water softening salt (3-packs)

Code: 90903005



#### Fragrance Pump

Available as an option for your steam generator and connects simply to the outlet pipe. Add any 5-litre concentrated fragrance. Code: 0038130

#### Concentrated fragrance

Suitable for professional use.

Eukaliptus: code 90024000

Peppermint: code 90024004

Lavender: 90024002

Citrus: 90024006



#### Bahia home and pro steam outlet

The Bahia steam outlet is the obvious choice for form, function and aesthetics. Tempered safety glass design with Corian® or high-gloss plastic.

Bahia Pro: tempered safety glass and Corian® Size: B:500mm / H:300mm. Code: 90029252

Bahia Home: tempered safety glass and high-gloss plastic. Size: B:280mm / H: 180mm. Code: 90029254



#### Sound system for steam room

Enhance your experience with a specially-designed sound system.

Code 90802010



#### Steam outlet grace

Steam head with integral dispenser for Tylo fragrances. Connect to the steam generator's steam pipe. Code: 96000558



#### Steam Nozzle

Positioned within the cabin to provide the most effective distribution of steam. Code: 7819604



#### Auto Drain Valve

Automatically drains water tank after every use, reducing limescale and minimising downtime for service. Includes connecting cable. 230VAC / 5W / IP67. Code: 4310135

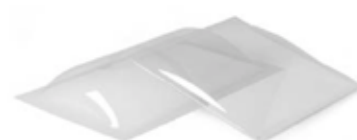

#### Domes

Turn your shower into a steam bath with a one-piece dome in special-grade plastic with assembly profiles of natural anodised aluminium. Made to measure (TK special). Max. length 200 cm. Domes can be fitted with profiles and doors. Contact customer care for made-to-measure orders.

# TyloHelo

## Steam Accessories

### TyloHelo Steam Accessories

#### Steam Room Door

Our top-quality doors are specially manufactured to withstand the considerable temperature differences between the outside and inside of the steam room without warping or becoming deformed.

Tempered safety glass door. Available with either tinted glass or clear glass. The new steam door G60 has no threshold, a major advantage in facilities requiring disabled access, and is fitted with four hinges to complement the designs of other doors in the DGL and DGB ranges.



#### Steam Door: tinted glass

- 9 x 19 right Code: 90912250
- 9 x 20 right Code: 90912254
- 9 x 21 right Code: 90912258
- 10 x 19 right Code: 90912262
- 10 x 20 right Code: 90912266
- 10 x 21 right Code: 90912270
- 9 x 19 left Code: 90912274
- 9 x 20 left Code: 90912278
- 9 x 21 left Code: 90912282
- 10 x 19 left Code: 90912286
- 10 x 20 left Code: 90912290
- 10 x 21 left Code: 90912294

#### Steam Door: clear glass

- 9 x 19 right Code: 90912252
- 9 x 20 right Code: 90912256
- 9 x 21 right Code: 90912260
- 10 x 19 right Code: 90912264
- 10 x 20 right Code: 90912268
- 10 x 21 right Code: 90912272
- 9 x 19 left Code: 90912276
- 9 x 20 left Code: 90912280
- 9 x 21 left Code: 90912284
- 10 x 19 left Code: 90912288
- 10 x 20 left Code: 90912292
- 10 x 21 left Code: 90912296



# TyloHelo

## Steam Accessories

### TyloHelo Steam Accessories

#### Steam Room LED Lights

Helo Steam Room Lights are LED lights, rated IP67. The set includes 4 LED lamps with silver heads, 1.5 metres of cable to each lamp, and the adapter. The colour of the lighting is warm white. The lighting has the property of directed emission with the scattering angle of 35.



#### Specifications

- 4pcs 5mm DIP LED
- 1.5m wire for each LED
- Connector with 4pcs holes
- Adapter with 12V, 500mA, European plug
- 4pcs/set in a white box
- Cover color: Silver
- Lighting color: warm white
- Wattage 0.65W±10%
- Luminous 39.3lm±10%
- Cable working temp -20-+85°C
- LED diode working temp -20-+90°C
- Humidity 0-95%RH
- Input voltage AC/DC12V
- Life time: 50,000h
- Scattering angle of 35 degrees

Code	Description
	<b>3815005</b> <b>Steam Room LED Light</b> 4pcs in a set with power adaptor 12V, 500mA



#### Steam Room Lighting

Helo Steam Room Lights rated IP67.

Code	Description
	<b>90011098</b> <b>Downlight with Halogen LED adapter</b> Light round LED.



# Steam Room

## Wall / Dome Construct

### Wall-Dome Construct

Atecpool building boards have a blue core made from CFC-free extruded polystyrene rigid foam.

This makes the Atecpool building board an ideal basis for any type of plaster and tile. Atecpool building boards can be applied to practically any substrate, waterproof, insulating, versatile, light and robust.

Atecpool Construct building board, offers many possibilities when it comes to designing customised forms. Whether you are looking for small radii or semicircular solutions, thanks to the pre-cut profiles the Construct building board gives you the freedom to be creative.

- The blue XPS core is 100% waterproof and remains fully functional even after possible damage.
- abP\*: building board butt joints can be sealed 100% simply by using adhesive sealant. As no other seal is necessary, craftsmen benefit from increased security accompanied by a shorter tiling time.
- The cemented surface is a good adhesive under-surface. The fibre fabric also absorbs tensile forces.
- All building board systems have great heat insulation properties,

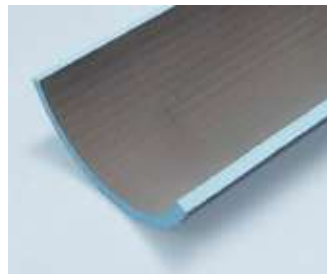
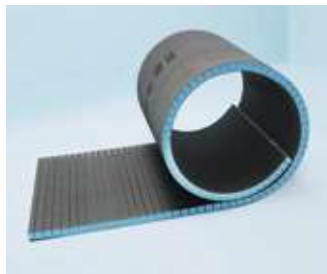

### Atecpool Wall-Dome Construct

Shapeable building boards.

Code	Description	Dimensions		
		mm		
		Length	Width	Thickness
W2500-600	Atecpool Building Board Wedi Construct	2500	600	30

### Building board construct, lengthwise, calculation of diameter

Thickness	External diameter
mm	mm
30	538

### Adhesive Sealant

Assembly materials for building boards.

Code	Description	Content
		ml
SEAL310	Adhesive Sealant for Wedi Construct	310 ml

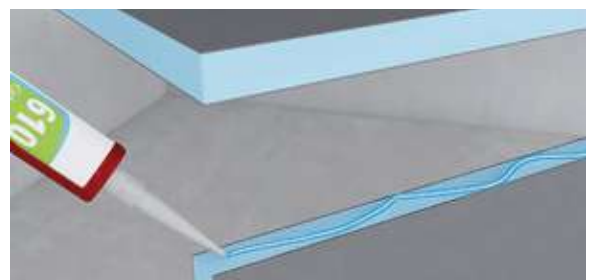

# TyloHelo

## Control Panels



### TyloHelo Control Panels

The user interface, developed for mobile devices and personal computers, perfectly emulates that of the steam room's or sauna's control panel. Through sensible engineering, the outcome is highly usable functionality, allowing bathers to log on to the control panel through the app over their local WiFi network and control their sauna and steam bath.

On both the control panel itself and via the app it is possible to create and save several different user profiles and favourite settings, and set different schedules. In commercial settings, it is possible to manage multiple units from one point of access, and set unique profiles for different locations.



### Elite > Effortless bathing

The new control panel Elite from TyloHelo is packed with advanced features, thanks to its internal processor and operating system. In addition to highly personalized settings, the Elite can be individually programmed according to your own schedule.

Add features such as auxiliary fans, fragrance pumps or lights - the Elite control panel handles it all with clear and concise precision. The 4.5-inch touch screen delivers real-time status on every aspect of your sauna and steam bath. Naturally, it includes steam and temperature settings and local WiFi app-connectivity.

#### Features

- Set temperature and humidity
- Can create multiple user profiles
- Control sauna/steam via local WiFi and app
- Set different schedules for different week days
- Set specific profiles for specific times or dates
- Instant fault notification



### Pure > Intuitive design and features

The elegant, compact design of TyloHelo's Pure control panel makes it the go-to choice for those who value functionality and simplicity. The thin black control lets you set the lighting, temperature and sauna time easily with only a few touches. Of course, choosing the start time up to ten hours in advance means you can step into a wonderfully hot sauna or steam as soon as you get home (Door contact needs to be added).

#### Features

- Touch control
- Temperature Display
- Set temperature/bath time
- Delayed start and Lighting control

# TyloHelo

## Control panels

### TyloHelo Control Panels

Model	Code	Size WxHxD	Features	For sauna or steam?	Suitable sauna heater	Relay box required?	Suitable steam generator	
		mm						
	<b>Pure</b>	72001430	85x127x12	Thermostat controlled touch control panel, for installation inside or outside the sauna or steam room.	Both	Sense Pure - included	No	Steam Home Steam Commercial
						Sense Combi Pure - included	No	
						Expression	Yes, relay box	Commercial Lite
						Sense Commercial 6-10 kW	Yes, relay box	Commercial Lite
						Sense Commercial 16-20 kW	Yes, relay box	Commercial
	<b>Elite</b>	72005040	85x127x12	The multi-disciplinary control panel is packed with advanced features, thanks to its internal processor and operating system. Naturally it includes energy saving functions and WiFi/App connectivity.	Both	Sense Elite - included	No	Steam Home
						Sense Combi Elite - included	No	
						Expression	Yes, relay box	Commercial Lite
						Sense Commercial 6-10 kW	Yes, relay box	Commercial Lite
						Sense Commercial 16-20 kW	Yes, relay box	Commercial Lite
	<b>H2</b>	96000544	80x140x19	H2 is equipped with touch-control and shows temperature and time in operating mode. Can be set for start within a 24-hour period and has a running time between 0-23 hours. Also equipped with a switch for lighting, 12h/24 format and multiple languages. With the H2 control panel, you can even preset the start program for one week in advance complete with repetitions, do troubleshooting and control the atmospheric humidity in the sauna room. Compatible with Tylo's older heater Sense Combi	Sauna	Expression Combi - included	Yes, relay box RB45 - included	No
	<b>OT 2 PLE</b>	OT2PLE	250x220x80	Control Unit, 400V, 3 phase, white.	Sauna	Helo Cup	No	No
	<b>WE40</b>	001352	-	WE 40 contactor box is compatible with the SKLE heater models 1051 - 1501 and with Cup heaters with an efficiency of 4.5 - 9 kW. Connection to PURE or ELITE panel through Contactor Box (WE40) for CUP and SKLE.				
	<b>WE50</b>	001351	-	WE 50 is for 230-240V 3 - voltage. SKLA models 181, 210, 260. Connection to PURE or ELITE panel through Contactor Box (WE50) for SKLA.				

# TyloHelo

## Infrared Cabins

### TyloHelo Infrared Cabins > Relax and Detox

With rapid heat-up time, your infrared room is energy efficient and ready-to-go at the blink of an eye. Experience the deep-penetrating heat that infrared heat therapy rooms and panels can provide. The infrared waves reach deeper into your tissues, relieving aching muscles of pain and stiffness.



### Benefits of Infrared Bathing

1.

#### Time-friendly

There's no waiting for an infrared sauna to heat up, so you can easily enjoy its benefits anytime.

2.

#### Planet-friendly

Even with daily use, Infrared technology uses as little or less electricity than many other common household appliances.

3.

#### Family-friendly

Infrared saunas are safe and easy to use for kids and adults alike.

4.

#### Releases muscle tension

The gentle warmth of infrared heat therapy rooms loosens muscle knots and relieves back pain. For active people the infrared treatment releases muscle tension and helps to prevent injuries and regenerate faster from training.

5.

#### Prevent flu and cold

Infrared sauna boosts blood circulation and helps stimulating the production of white blood cells, aiding the immune system in its response to virus and bacteria. Regular sauna bathing dramatically lowers the risk of catching common colds, even those caused by viruses.

6.

#### Stress less and relax more

Finding stress relief and ways to relax is fundamental to our health. Infrared sauna promotes relaxation and balances the body's levels of cortisol. Cortisol is a stress hormone, and excessive amounts of it can result in many different health issues such as a weaker immune system, weight problems and insomnia. The heat also raises that amount of serotonin, the "feel good-hormone", in our blood.

7.

#### Supporting heart health

The high temperatures in the sauna increase the heart rate, thereby giving the heart a healthy "workout". Infrared saunas can also lower blood pressure, something that provides a similar effect.

# TyloHelo

## Infra-red Cabins

### Infrared Rooms

#### T-810 Series 1-Person



Size: 913x913x1938mm  
Code: 95109100

Size: 913x913x1938mm  
Code: 95109110

#### T-870 Series 3-Person



Size: 1301x1301x1938  
Code: 95109106

Size: 1301x1301x1938  
Code: 95109116

#### T-820 Series 2-Person



Size: 1213x1013x1938mm  
Code: 95109102

Size: 1213x1013x1938mm  
Code: 95109112

#### T-825 Series 2-3 Person



Size: 1633x1078x1938mm  
Code: 95109104

Size: 1633x1078x1938mm  
Code: 95109114

#### Combination Sauna 2 in 1

Why limit your sauna enjoyment? Enjoy the infrared heat in a traditional Tylo sauna! Our efficient IR panels are in hemlock wood and the fabric is now available in both black and grey. Install as separate panels in an existing traditional sauna room or as a complete set in a separate infrared sauna room.



# TyloHelo

## Infra-red Cabins



### TyloHelo Infrared Cabins > Relax and Detox

Fast assembly with no tools—with wall panels mounted onto an easy-fit base and topped with easy-fit ceiling panel. Prefabricated wall panels, benches and floor in clear Hemlock—for a sauna with “furniture quality”. The exterior surfaces are finished with biodegradable wood treatment—for a more luxurious look and for ease of maintenance. The CarbonFlex® infrared heaters, integral with wall panels, with heater surface area and wattage designed to give even, enveloping heat on all sides.

#### Infra Panel

**Black** 980 x 360 mm, 150w, 230V. Code: 90011295

**Grey** 980 x 360 mm, 150w, 230V. Code: 90011295G

**Black** 980 x 680 mm, 300w, 230V. Code: 90011298

**Grey** 980 x 680 mm, 300w, 230V. Code: 90011298G



#### Infra Wi-Fi IR2 Control Panel

- Wi-Fi capability
- Mobile app available with worldwide functionality from anywhere there is cell or data service
- Dimensions: H 141 mm, W 84,5 mm, D 8 mm
- Intuitive display (time/temp/lighting/system status)
- 24-hour time delay via Mobile App
- 60-minute timer
- Built-in RGBW light control with dimmer
- Built-in Bluetooth audio
- Voice control compliant with Alexa, Google and Siri

### Color therapy > Psychological and therapeutic effects of color.

Psychological and therapeutic effects of color.



#### Red

Is the symbol of love and of life itself; with its penetration power, which is the highest of all colours; it is recommended for treatment of impeded circulation, muscles and heart. It generates enthusiasm, arouses passion and has a cheering effect.



#### Yellow

Is a clear purifying colour, which stimulates clarity of intellect, as well as toxin processing and elimination. It can help with learning disabilities and with strengthening of the endocrine functions.



#### Green

Is a cooling, sedating colour, which helps reduce swelling of joints and tissues; it calms the body and helps reduce inflammation. It's the colour of the relaxed heart.



#### Turquoise

Is the colour for mental relaxation and tackling embedded psychological barriers. It acts as a tonifier and can help regulate imbalances in the lung and large intestine system. It is a colour that facilitates spiritual growth.



#### Blue

Is a cool colour that has a calming effect, inside as well as on the outside. It is very helpful in treating sleep disorders and headaches, yet also smooth elasticity of muscles in the organism. It helps in all kinds of cramps and can have an antibacterial effect.



#### Violet

Promotes awareness and consciousness. It increases effects of meditation. It promotes proper functioning of the lymphatic system and is a very helpful in times of menopause. It is the colour for neutralizing emotional wounds and for spiritual growth.

# Experience Shower

## 4 Seasons shower

### Atecpool Experience Shower

The four seasons bi-thermal shower model, provides a gentle and abundant shower of water, produced by a 40 cm diameter shower head that has multiple micro-nozzles. Given the size of the surface area, this shower head generates a delightful and plentiful rainfall on the body, combined, in addition, with cold and warm water misting nozzles that provide a thermal contrast that relaxes and tones muscles.

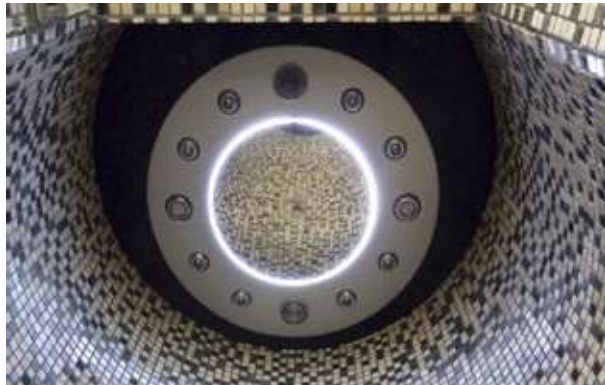

### Specifications

- Round chrome shower head, 40 cm in diameter with white LED perimeter lighting.
- 4 large misting nozzles.
- 4 fine misting nozzles.
- 2 RGB LED light fittings.
- Music therapy stereo system with two 5w speakers and perimeter RGB LED lighting.
- The shower is operated using four push buttons, one for each season.

### Required Facilities

- Hot water supply, 15 ltr/minute continuously
- Cold water supply, 35 ltr/minute continuously at 3 bar of pressure.
- Power supply line protected by a differential and thermal breaker for 500W
- Syphon drain with an absorption capacity of 35 ltr/minute.

### Musictherapy



Code	Description
ATD21124	Atecpool Experience 4 Seasons Shower Chrome High Flow Showerhead Ø 400 mm Combined w/ 8 Water Jets on a Solid Surface Frame Ø 720 mm with a Matt Aluminium Finish

The shower includes music stereo equipment comprising two 5 w speakers with perimeter RGB LED lighting controlled using an electronic board with MP3 and USB. The equipment includes a USB memory stick with four factory-installed music themes\*. (\* If users wish to change the music themes, the USB's file order as well as the name and total length of the music must coincide with the original.)

### Chromotherapy



The shower includes four LED lamps (red, green and blue). The colours are automatically assigned by the manufacturer and vary according to the programme selected. The shower has white LED lighting when this option is not activated. As soon as it is switched on the lighting will begin according to the selected programme.

### Nebulizer Sprinkler



The shower has 9 sprayheads: a main shower head, four fine mist nozzles and four large mist nozzles.

# Ice Fountain

## Therapeutic thermal contrast

### Atecpool Ice Fountain

The ice fountain's therapeutic goal, like the frigidarium, is providing the maximum thermal contrast in the thermal spa cycles. It is very advisable for the general body stimulation, mainly for its vasoconstrictor effect that gives flexibility to the circulatory system. Unlike the frigidarium, its use is much more traditional since it consists in applying frosted ice on the surface of the body in whichever way you desire. This therapeutic complement offers our customers the possibility to obtain exactly the same sensations that people obtain with a sauna session in the Baltic areas, where the sauna is always combined with a snow or ice massage to obtain the maximum effect of the thermal spa session.



### Ice drop tube



### Variety of containers



### For frigidariums or independent



### Ice Keeper



### Ice Machine / Modular Electronic Ice Equipment



### Example of installation in an adjacent room

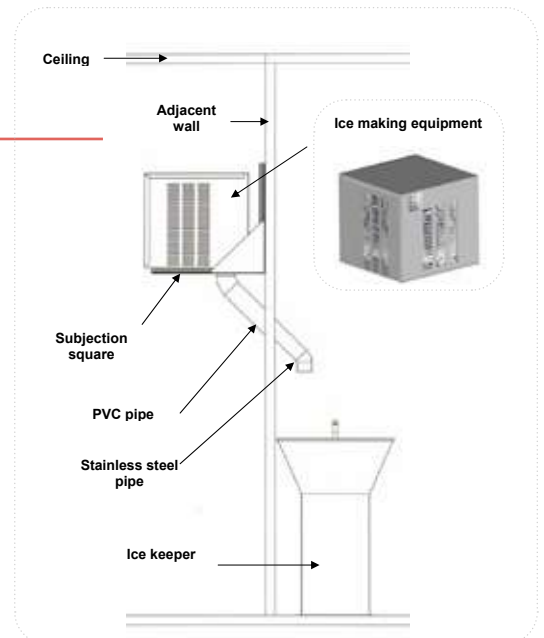



# Vichy Shower

## Thermotherapy shower

### Vichy Shower

The Vichy Shower is a thermotherapy equipment consisting of a longitudinal structure with in-line sprinklers and a programmable circuit whose main function is to improve the effectiveness of massage and facilitate body hygiene during physiotherapist treatments with mud and algae. The massage is given lying on a stretcher under microderrums of bithermal alternating water thanks to 5 sprinkler units with orientation ball and anti-clogging system. The Vichy bithermal shower is fully automatic and works by touch screen with microprocessed electronic programmer.



### Specifications

- Articulated stainless steel arm anchored to a support fixed to the wall where the shower is located. The arm include 5 sprinklers are placed with independent taps to use sprinklers that are of interest depending on the massage is performed. Sprinklers have three positions, Rain, massage, or nebulizer.
- Table bed, cushion, rubber and elastic mattress. This table measures 70cm. wide and is usually placed in a cabin that makes at least about 65 cm on each side of the table.
- Beneath the bed take a drain with a slope of 2% connected to a tube able to withstand 50 L / min. In the room also is needed a safety drain.
- Digital display panel with built-in to change the various programs of showers.
- Hydraulic safety valves box for the water run and cut, prefilters, mixing valve to regulate the temperature of water.
- Optional element. Optional special therapeutic kit, injection of aroma, for the different massages.



Code	Description
ATV20226	Atecpool Articulated Arm Bithermal Vichy shower w/ Sprinklers in SS, 5 valves, 5 sprinklers w/ Three types of Shower: Rain, Massage and Mist.
ATV20227	Atecpool Fixed Arm Bithermal Vichy shower w/ Sprinklers in SS, 5 valves, 5 sprinklers w/ Three types of Shower: Rain, Massage and Mist.

# Wellness

## Portable Spas

### Spa Corsica

#### Specifications

Size: 2900 X 2300 X 980mm  
Capacity (seats / loungers): 8 (7 / 1)  
Power consumption: 7500W  
220 - 240V / 50 - 60Hz  
Water Jets + Air Jets = 108 + 12  
Pop-up Head rest: 4  
Balboa Control System  
Wooden Cabinet w/ steps  
Heavy duty Spa Cover  
Acrylic Shell



### Spa Bonaire

#### Specifications

Size: 2300 X 2300 X 980mm  
Capacity (seats / loungers): 5 (3 / 2)  
Power consumption: 6500W  
220 - 240V / 50 - 60Hz  
Water Jets + Air Jets = 87 + 12  
Pop-up Head rest: 3  
Balboa Control System  
Wooden Cabinet w/ steps  
Heavy duty Spa Cover  
Acrylic Shell



# Wellness

## Portable Spas

### Spa Bora Bora

#### Specifications

Size: 2400 X 2400 X 980mm  
Capacity (seats / loungers): 5 (4 / 1)  
Power consumption: 7500W  
220 - 240V / 50 - 60Hz  
Water Jets + Air Jets = 87 + 12  
Pop-up Head rest: 5  
Balboa Control System  
Wooden Cabinet  
Heavy duty Spa Cover  
Acrylic Shell



### Spa Lanzarote

#### Specifications

Size: 2400 X 2400 X 930mm  
Capacity (seats / loungers): 7 (5 / 2)  
Power consumption: 7000W  
220 - 240V / 50 - 60Hz  
Water Jets + Air Jets = 195 + 12  
Pop-up Head rest: 4  
Balboa Control System  
Wooden Cabinet w/ steps  
Heavy duty Spa Cover  
Acrylic Shell



# Wellness

## Portable Spas

### Spa Ibiza

#### Specifications

Size: 2180 X 1900 X 995mm  
Capacity (seats / loungers): 3 (2 / 1)  
Power consumption:  
220 - 240V / 50 - 60Hz  
Water Jets + Air Jets = 46 + 12  
Pop-up Head rest: 3  
Balboa Control System  
Wooden Cabinet w/ steps  
Heavy duty Spa Cover  
Acrylic Shell



### Spa Mallorca - Recovery Spa

#### Specifications

Recovery Spas for HydroTherapy. Choose your medical spa programme with SPA Mallorca.  
Size: 3400 X 2280 X 1360/1500mm  
Capacity (seats: 3  
Power consumption: 220 - 240V / 50 - 60Hz  
Water Jets= 10  
Pop-up Head rest: 2  
Balboa Control System  
Heavy duty Spa Cover  
Acrylic Shell  
Lifting Gear (as optional)



# Wellness

## Portable Spas

### Spa Escada

#### Specifications

Size: 2150 X 1900 X 800mm

Capacity (seats): 6 adults

Heater system: 2870W

220 - 240V / 50 - 60Hz

Water Jets + Air Jets = 78 + 12\*

Multi color LED light in the cabinet

Perfect core-therapy control center

Multicolor LED Waterfall

Heavy Duty SPA Cover



### Spa Cleopatra

#### Specifications

Size: 2300 X 2300 X 930mm

Capacity (seats): 5 adults + 2 children

Heater system: 2870W

220 - 240V / 50 - 60Hz

Water Jets + Air Jets = 78 + 10\*

Multi color LED light in the cabinet

Perfect core-therapy control center

Multicolor LED Waterfall

Heavy Duty SPA Cover



\* Air Jets as optional

# Wellness

## Portable Spas

### Spa Elegance

#### Specifications

Size: 2300 X 2300 X 930mm  
Capacity (seats): 6 adults + 1 baby  
Heater system: 2870W  
220 - 240V / 50 - 60Hz  
Water Jets + Air Jets = 76 + 12\*  
Perfect core-therapy control center  
Multicolor LED Waterfall  
Heavy Duty SPA Cover

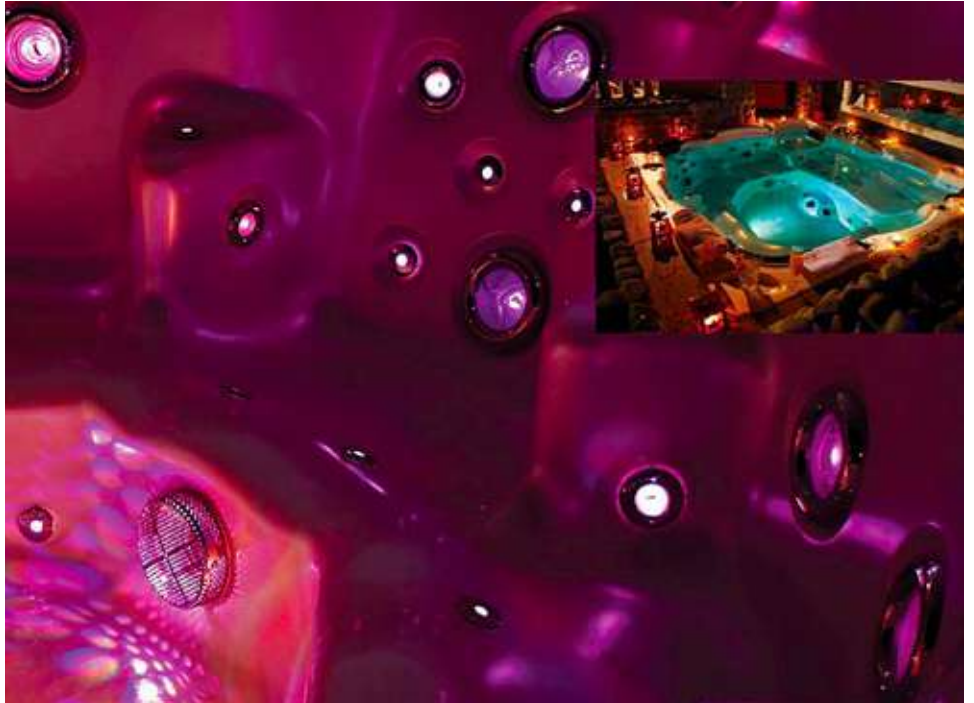
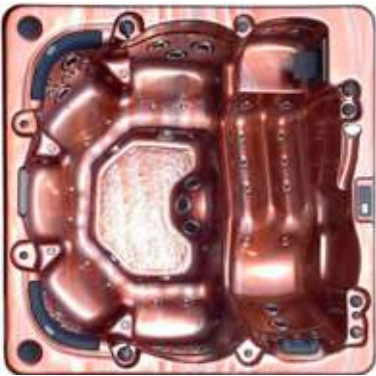

### Spa Nereid

#### Specifications

Size: 2800 X 2300 X 930mm  
Capacity (seats): 8 adults + 3 children  
Heater system: 2870W  
220 - 240V / 50 - 60Hz  
Water Jets + Air Jets = 106 + 10\*  
Perfect core-therapy control center  
Multicolor LED Waterfall  
Heavy Duty SPA Cover



\* Air Jets as optional

# Wellness

## Portable Spas

### Spa Fairy

#### Specifications

Size: 2150 X 1900 X 630mm

Capacity (seats): 5 adults

Heater system: 2870W  
220 - 240V / 50 - 60Hz

Water Jets + Air Jets = 45 + 8\*

Perfect core-therapy control center

Panel with marble stone corners

Multicolor LED Waterfall



### Spa Grace

#### Specifications

Size: Ø2280 X 930mm

Capacity (seats): 7 adults

Heater system: 2870W  
220 - 240V / 50 - 60Hz

Water Jets + Air Jets = 77 + 12\*

Perfect core-therapy control center

Multicolor LED Underwater Light

Heavy Duty SPA Cover



\* Air Jets as optional

# Wellness

## Spa Details

### Jets used in Portable Spa

The size and the arrangement of jets influence remarkably the effectiveness of hydromassage. In Atecpool Royal Collection Portable Spas 4 types of jets have been used: big rotating jets, medium rotating jets, medium adjustable jets and mini back jets. The designed rotational jets, during the flow of water stream are circulating, in this way preventing the spot action of the water stream. This solution guarantees that the largest amount of nerve receptors are massaged. The regular massage improves the health condition of the inside organs and in case of back muscles, improves the physical condition as well as the appearance of the figure.



### Multiple Jets

1. Big rotating jets with the possibility of water massage regulation.
2. Medium rotating jets
3. Medium jets with the possibility of directing the water stream
4. Mini rotational jets

### Chromotherapy and Aromatherapy

#### Chromotherapy Underwater Light

The use of chromo therapy, that is the treatment with light and colors, has a very positive impact on the regeneration of the human organism. That is why our portable spas are equipped with the light with the changeable colors. The system is based on the electronic control of the colored lamp LED. This gives the possibility of individual adjustment of the colors, which influences directly the effectiveness of chromo therapy. Minimum dimensions of the manhole result from possibility of an easy entrance and removing the element to be repaired and should be 60x60cm.



#### White

harmonizes and restores the balance in the organism.

#### Blue

among others reinforces the immunity, soothes the throat, eyes, pains, and acts in a soporific and calming manner.

#### Green

among others calms, refreshes, improves the mood, supports the metabolism, regenerates the brain and the nerve system.

#### Yellow

is the antidote to stress and tiredness, reinforces the muscles, improves the texture of the skin.

#### Red

among others warms up, improves blood circulation, gives energy and stimulates to energetic activity.

#### Aromatherapy

Aromatherapy functions during the work of air massage. The air, before it is being blown into the spa, goes through the special chamber, in which the aromatherapy bags are placed. Afterwards it goes to the bath through the network of small holes and with the aired stream of water. It is very effective and at the same time high efficient aromatherapy system, used in portable spas. It guarantees the wonderful effects, and at the same time does not cause the turbidity of the water, prevents the oil suspensions in the water, which very often cause the dirtiness of both the acrylic surface as well as hydro massage elements



# Wellness

## Spa Selection & Accessories

### Spa Accessories Design

Atecpool Royal Collection is the true expression of wellness, our professional spa offers premium cabinets of your choice. Selection of Spa Covers and Composite Panel for cabinet available with our Royal Collection.



### Portable Spa Colours



white



gypsum



azure



oyster



graphite

### Spa Cover Colours



be-16



sa-2



n-7



br-2



cz

### Spa Composite Panel Colours



blanc creme  
ral 9001



gris basalte  
ral 7012



bleu violet  
ral 5000

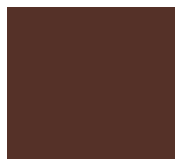

brun chocolat  
ral 8017

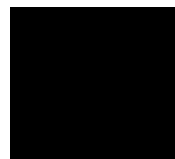







noir profond  
ral 9005

# Wellness

## Portable Spas

Above Ground Spas with cabinet - Comparison

Code	Spa Corsica	Spa Bonaire	Spa Bora Bora	Spa Lanzarote	Spa Ibiza	Spa Mallorca
						
<b>General Information</b>						
Size (mm)	2900x2300x980	2300x2300x980	2400x2400x980	2400x2400x930	2180x1900x995	3400x2280x1360/1500
Water capacity (gal)	380	286	352	396	220	1100
Colour	White	White	White	White	White	White
Capacity (persons)	8	5	6	7	3	3
Power supply	220-240V/50-60HZ	220-240V/50-60HZ	220-240V/50-60HZ	220-240V/50-60HZ	220-240V/50-60HZ	220-240V/50HZ
Shell	Acrylic	Acrylic	Acrylic	Acrylic	Acrylic	Acrylic
<b>Composition</b>						
Hot Tub	1	1	1	1	1	1
Head rest	4 (pop-up)	3 (pop-up)	5	4	3	2
Steel frame	1	1	1	1	1	1
Water Flow Equipment	1	1	-	-	-	-
Waterfall	-	-	1	1	-	-
LED Air Jets	12	12	-	-	12	-
Air Jets	-	-	12	12	-	-
Water jets	77	87	87	142	46	10
Fountain jets	-	-	2	2	-	-
Swim jet	-	-	-	-	-	-
Shoulder Massage Jets	-	-	-	2	-	-
Hydro Therapy Jets	31	28	33	17	-	10
LED Lights	-	-	1	1	-	1
Fiber Optic Lights	43	34	33	36	29	35
Fountain valves	-	-	1	1	-	-
Water Flow Valves	1	1	-	-	-	-
Waterfall Valves	-	-	1	1	-	-
Shoulder Massage Valves	-	-	-	1	-	-
Drain valves	1	1	1	1	-	1
Intake valves	5	3	4	5	3	2
Diverter valves	2	1	2	2	1	-
Air Control valves	5	3	5	5	3	2
Wooden cabinet	•	•	•	•	•	-
Insulation	•	•	•	•	•	•
Heavy Duty Spa Cover	•	•	•	•	•	•
Wooden Step	•	•	•	•	•	-
Aromatherapy	•	•	•	•	•	-
View Pump	-	-	-	-	-	-
Hydro Massage Pump	2 x 3.0 HP / 1 x 2.0 HP	1 x 3.0 HP / 2 x 2.0 HP	3 x 2.0 HP	1 x 3.0 HP / 2 x 2.0 HP	1 x 3.0 HP / 1 x 2.0 HP	1 x 3.0 HP
Circulation Pump	1 x 1.0 HP	1 x 1.0 HP	1 x 1.0 HP	1 x 1.0 HP	1 x 0.35 HP	1 x 1.0 HP
Swim Pump	-	-	-	-	-	-
Fountain Pump	-	-	1 x 0.35 HP	1 x 0.35 HP	-	1 x 0.35 HP
Air Blower	1 x 0.7 kW	1 x 0.7 kW	1 x 0.7 kW	1 x 0.7 kW	1 x 0.7 kW	1 x 0.7 kW
Ozonator	1	1	1	1	1	1
Heater	1 x 3.0 kW	1 x 3.0 kW	1 x 3.0 kW	1 x 3.0 kW	1 x 3.0 kW	1 x 3.0 kW
Cartridge Filter	1	1	-	-	1	2
Pressure Filter	1	1	-	-	1	-
Skimmers	-	-	2	2	-	2
Controller	1	1	1	1	1	1
<b>Optional</b>						
Balboa Control System	•	•	•	•	•	•
Swim tether	-	-	-	-	-	-
Aquatic Rowing System	-	-	-	-	-	-
Aquatic Fitness Rope	-	-	-	-	-	-
Bar + Stool Package	•	•	•	•	-	•
15" Television	• (Inward)	• (Inward)	Included (32", Inward)	• (Inward, Outward, Pole)	• (Pole)	• (Inward, Outward, Pole)
Topside Music	•	•	Included (4 nos)	•	•	•
DVD	•	•	Included	•	•	•
Tub Tray	•	•	Included	•	•	•
Winter Cover	•	•	•	•	•	•
PVC Cabinet	•	•	•	•	-	•

# Wellness

## Portable Spas

### Above Ground Spas with cabinet - Comparison

Code

Spa Escada

Spa Cleopatra

Spa Elegance

Spa Nereid

Spa Fairy

Spa Grace



General Information						
Size (mm)	2150x1900x800	2300x2300x930	2300x2300x930	2800x2300x930	2150x1900x630	Ø2280x930
Seating capacity	6 adults	5 adults + 2 children	6 adults + 1 baby	8 adults + 3 children	5 adults	7 adults
Water volume (liters)	1432	2380	2380	2785	1122	1760
Gross weight (kg)	320	455	435	611	180	365
Net weight (kg)	300	435	415	585	155	345
Water massage jets (total)	78	78	76	106	45	77
Air jets	12*	10*	12*	10*	8*	12*
Safe suction	3 pcs	3 pcs	3 pcs	3 pcs	2 pcs	3 pcs
Skimmer	1 set	1 set	1 set	1 set	1 set	1 set
Water massage pump	2x2 Hp	2 x 2 Hp	2 x 2 Hp	2 x 3 Hp	1 x 3 Hp / 1 x 1 Hp	2 x 2 Hp
Circulation pump	1 x 0.5 Hp	1 x 0.5 Hp	1 x 0.5 Hp	1 x 0.5 Hp	1 x 0.5 Hp	1 x 0.5 Hp
Blower system	yes*	yes*	yes*	yes*	yes*	yes*
Heater system	2870W	2870W	2870W	2870W	2870W	2870W
Ozone system	450ml/h	450ml/h	450ml/h	450ml/h	450ml/h	450ml/h
Freeze protection	yes	yes	yes	yes	yes	yes
Flow protection	yes	yes	yes	yes	yes	yes
Perfect-core Therapy Control Center	yes	yes	yes	yes	yes	yes
Weatherable Polymer Cabinet	1 set	1 set	1 set	1 set	1 set	1 set
LED cup seat	3 pcs*	8 pcs*	-	3 pcs*	-	-
Bottom panel	yes*	yes*	yes*	yes*	yes*	yes
Insulation foam	A coat PU foam	A coat PU foam	A coat PU foam	A coat PU foam	A coat PU foam	A coat PU foam
Multi-color LED under water light	1 pc	1 pc	1 pc	1 pc	1 pc	1 pc
Multi-color LED light in the skit	4 panel*	1 pc	1 pc	-	4 panel*	1 pc
Waterfall luminescence multi-color LED light system	•	•	•	•	-	•*
Luminescence multi-color LED lighting system	•*	•	•	•*	•*	•*

Note: Items with "\*" are optional, need to order separate

# Wellness

## Portable Spas

### Spa Sumatra

#### Specifications

Size: Ø2180 X 880mm

Capacity (seats): 8

Power Supply:

220 - 240V / 50 - 60Hz

Water Jets + Air Jets = 9 + 12

Volume: 176 gal

Plumbed Shell with jets and MEP equipment.

In-ground / above ground installation



### Spa Rose

#### Specifications

Size Ø2400 X 1000mm

Capacity (seats): 6

Power Supply:

220 - 240V / 50 - 60Hz

Water Jets + Air Jets = 26 + 12

Water capacity: 252 gal

Plumbed Shell with jets and MEP equipment

In-ground / above ground installation



# Wellness

## Portable Spas

### Spa Jawa

#### Specifications

Size: 2260X1910X980mm

Capacity (seats): 7

Power Supply:  
220 - 240V / 50 - 60Hz

Water Jets + Air Jets = 7 + 12

Water capacity: 176 gal

Plumbed Shell with jets and MEP  
equipment.

In-ground / above ground installation.



### Spa Mandura

#### Specifications

Size Ø3800 X 2400 X 1000mm

Capacity (seats): 14

Power Supply:  
220 - 240V / 50 - 60Hz

Water Jets + Air Jets = 88 + 28

Water capacity: 486 gal

Plumbed Shell with jets  
and MEP equipment



# Wellness

## Filtration Kit for In-Ground Spas

### Massage System, Filtration and Dosing of Chemicals

All the models in the In-Ground version possess the overflow gutter according to the European norms. The set up of parameters used in the filtration system is consistent with the DIN 19643 standard. The water filtration system includes: an integral overflow gutter, equalization tank, circulation pump, sand filter, water heating and the disinfection system. In the In-Ground version, all hydromassage and filtration appliances, except for the filter, are installed on the palette 100 x 150cm, placed together with the equalizing tank and the filter in a separate room. In the hydromassage system two massage pumps 1,1 kW have been used; the air massage system includes high capacity, radial air blower 1,3 kW. The heating system is based on the heat exchanger and the disinfection system is the automatic system with its own dosing pumps and the electronic measure of pH and content of chlorine.



Filtration System for In-Ground Spas mounted on a palette



Chemical Dosing for In-Ground Spas

### Requirements for a technical room assigned for equipment installation:

1. Distance of the room from the bathroom.
2. Level of the technical room.
3. Dimensions of the machine room.
4. Other utilities of the machine room.





It is recommended to install the accompanying equipment in a separate room, in the way assuring the easy access in order to make the conservation maintenance service (filter, working valves etc). The distance between the machine room and the bath should not exceed 10 m. The floor of machine room has to be below the level of water in the spa (for better filtration and hydromassage). In this position the filtration pump and hydromassage pumps is flooded gravitationally.

- Spas for private use are provided with a standard pallet of dimensions of 100 x 150 cm. . Minimum dimensions of the machine room are 1.5 x 2.0 m, i.e. 3 m<sup>2</sup> (if the equalising tank is to be installed in the machinery room, the room area should be increased minimum by 3,5 m<sup>2</sup>)
- The public spas require sand filter, size to be selected upon volume and usage. The size of the palette on which all the equipment together with the control box (except for sand filter) is placed, is 100 x 150 cm. The minimal dimensions of the machinery room: 3 x 2,5 m, that is 7,5 m<sup>2</sup> (in case of assembling the balance tank in the machine room, the room size should be increased minimum by 3,5 m<sup>2</sup>)

# Wellness

## Portable Spas

Portable Spas - Comparison

Code	SPA Sumatra	SPA Rose	SPA Jawa	SPA Mandura
				
General Information	Plumbed shell with MEP equipment	Plumbed shell with MEP equipment	Plumbed shell with MEP equipment	Plumbed shell with MEP equipment
Size (mm)	Ø2180×880	Ø2400×1000	2260×1910×980	3800×2400×1000
Water capacity (gal)	176	252	176	486
Colour	White	White	White	White
Capacity (persons)	8	6	7	14
Power supply	220-240V/50-60HZ	220-240V/50-60HZ	220-240V/50-60HZ	220-240V/50-60
Shell	Acrylic	Acrylic	Acrylic	Acrylic
Composition				
Bath Tub	1	1	1	1
Shelf	1	1	1	3
Air Jets	12	12	12	1
Massage Jets	9	-	7	-
Hydro Therapy Jets	-	26	-	1
SPA Lights	1	1	1	-
LED Optic Lights	-	14	-	12
Water Pipe	1	-	1	72
Drainage	1	1	1	2
Return	2	-	2	-
Transformer	1	-	1	-
Intake valves	-	2	-	19
Drainage Grille	-	1	-	2
Insulation	(Optional)	1	(Optional)	21
Hydro Massage Pump	-	2 x 2.0 HP	-	3 x 3.0 HP
Circulation Pump	-	1 x 1.0 HP	-	1 x 1.0 HP
Whirlpool Pump	2 x 1.5 HP	-	2 x 1.5 HP	-
Supply Pump	-	1 x 0.35 HP	-	1 x 0.35 HP
Air Blower	1 x 0.7 kW	1 x 0.7 kW	1 x 0.7 kW	2 x 0.7 kW
Ozonator	1	2	1	2
Heater	1 x 3.0 kW	1 x 3.0 kW	1 x 3.0 kW	1 x 3.0 kW
Cartridge Filter	1	1	1	1
Supply System	-	1	-	1
Water Tank	-	1	-	2
Controller	1	1 Balboa	1 Balboa (Optional)	1 (Balboa)
Optional				
15" Television	● (Pole)	-	-	-
Heavy Duty Spa Cover	-	●	●	●
i-pod	-	●	-	●
Subwoofer	-	-	-	●
Tub Tray	-	●	-	●
Winter Cover	●	●	-	●
PVC Skirt	-	●	●	●
PVC Step	-	●	●	●
Wooden Step	●	-	-	-
Wooden Skirt	●	-	-	-
Other Shell Colour	-	●	●	-
R10 Insulation	-	●	-	-

# Warming Mat

## Atecpool heating mat

### Atecpool Warming Mat - Floor warming Systems

Combine the highest comfort levels with maximum energy efficiency. It's a proven technology which is safe, reliable and energy efficient.



### Features

- Single point connection
- Twin conductor cable
- Emits zero EMF (electromagnetic fields)
- Safety approved for wet locations
- Flexible installation
- Durable construction
- 25-year limited warranty against manufacturing defects
- The Warming Mat system includes a blue heating cable woven into an adhesive-backed red fiberglass mesh that allows for simple roll-out installation without worrying about heating cable spacing.

### Atecpool Warming Mat - Heated Massage Beds

Tiled Massage beds with ATECPPOOL Warming Mat. Used in Moroccan baths and Turkish Hamams for heated surface. Warming Mat applied beneath the plastering below the tiles with safety features. Completely regulated temperature control and easy installation.



### Atecpool Warming Mat Specifications

Cable Construction:	Twin conductor
Rated Voltage:	230V
Output:	150W/m <sup>2</sup> & 200W/m <sup>2</sup>
Cable Spacing:	80mm (150W/m <sup>2</sup> ) & 80mm (200W/m <sup>2</sup> )
Cable Diameter:	3.6mm
Conductor Insulation:	Fluoropolymer
Outer Insulation:	PVC
Max. Ambient Temp:	85°F (30°C)
Min. Installation Temp:	40°F (5°C)
Cold Lead	2-wire plus ground braid; 2.5m length





# Warming Mat

## Atecpool heating mat

### Atecpool Warming Mat - Touch Screen Programming Thermostat

Weekly circulation digital programming thermostat with LCD touch screen, which has 6 events everyday. Manual and programming mode could be selected. The thermostat is recommended for control of electric heating devices.



Code	Voltage (V)	Dimensions (mm)	Power (W)	Amps (A)
WMT5001	220 / 230	86x86x44	2	15 (max)

### Atecpool Warming Mat - Floor warming Systems

Selection of Warming Mat based on the floor material, thickness and area. Used with wood, tiles, marble and stone flooring.

Code	Heated Area (m <sup>2</sup> )	Mat Dimensions (mtr x mtr)	Power (150W/m <sup>2</sup> ) (W)	Amps (A)	Resistance Ω
WM150-1	1.0	0.5x2	150	0.7	352.7
WM225-1	1.5	0.5*3	225	1.0	235.1
WM300-2	2.0	0.5*4	300	1.3	176.3
WM375-2	2.5	0.5*5	375	1.6	141.1
WM450-3	3.0	0.5*6	450	2.0	117.6
WM535-3	3.5	0.5*7	525	2.3	100.8
WM600-4	4.0	0.5*8	600	2.6	88.2
WM675-4	4.5	0.5*8	675	2.9	78.4
WM750-5	5.0	0.5*10	750	3.3	70.5
WM900-6	6.0	0.5*12	900	3.9	58.8
WM1050-7	7.0	0.5*14	1050	4.6	50.4
WM1200-8	8.0	0.5*16	1200	5.2	44.1
WM1350-9	9.0	0.5*18	1350	5.9	39.2
WM1500-10	10	0.5*20	1500	6.5	35.3
WM1800-12	12	0.5*24	1800	7.8	29.4

Code	Heated Area (m <sup>2</sup> )	Mat Dimensions (mtr x mtr)	Power (200W/m <sup>2</sup> ) (W)	Amps (A)	Resistance Ω
WM200-1	1.0	0.5*2	200	0.9	264.5
WM300-1	1.5	0.5*3	300	1.3	176.3
WM400-2	2.0	0.5*4	400	1.7	132.3
WM500-2	2.5	0.5*5	500	2.2	105.8
WM600-3	3.0	0.5*6	600	2.6	88.2
WM700-3	3.5	0.5*7	700	3.0	75.6
WM800-4	4.0	0.5*8	800	3.5	66.1
WM900-4	4.5	0.5*8	900	3.9	58.8
WM1000-5	5.0	0.5*10	1000	4.3	52.9
WM1200-6	6.0	0.5*12	1200	5.2	44.1
WM1400-7	7.0	0.5*14	1400	6.1	37.8
WM1600-8	8.0	0.5*16	1600	7.0	33.1
WM1800-9	9.0	0.5*18	1800	7.8	29.4
WM2000-10	10	0.5*20	2000	8.7	26.5
WM2400-12	12	0.5*24	2400	10.4	22.0

# Wellness

## Stainless Steel Relaxation

### Air Bed Massage AISI 316

Made of Stainless Steel AISI 316. Ergonomically designed massage accessory with air jets in the back, lumbar and leg regions. The bed is comprised of stainless steel casing with air holes situated in the key massage areas. The range includes both a single and double model.



### Specifications

- 140 orifices: Ø2.5mm
- 2 intakes on the base
- PVC installation base support (not included)
- Female connection: 1"
- Airflow: 245 m<sup>3</sup>/h
- Recommended blower: AH420-321 2,2kW

Code	Description	Dimensions				Weight
		A	B	C	D	
015993	Air Bed Massage AISI 316	560 mm	1445 mm	75 mm	370 mm	45

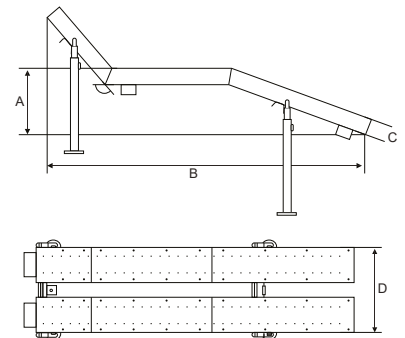

### Foot Massage AISI 316

Made of Stainless Steel AISI 316. Available in three models: square, circular and rectangular air bubble systems. Custom size upon request.



Code	Description	Dimensions	Weight
		mm	Kg
015995	Circular Foot Massage AISI 316	Ø345	3.8
015996	Square Foot Massage AISI 316	300 X 300	5.5
015997	Square Foot Massage AISI 316	500 X 500	14.5
015998	Square Foot Massage AISI 316	750 X 750	28.5
015999	Rectangle Foot Massage AISI 316	520 X 170	3.8

# Wellness

## Massage Relaxation

### Air Bed Massage

Air bed massage in fiberglass construction is specially designed for spa center swimming pool. Sit and relax, enjoy full body massage. Flow required : 23 m<sup>3</sup>/hr



#### Specifications

- Dimensions: 1800 x 680 mm
- Water massage jets: 11
- Feet massage: yes
- Shoulder massage: yes
- Hand twist spa system: yes
- Perfect therapy control center: yes

Code	Description	Dimensions	
		Length	Width
0159AM	Air Bed Massage Fiberglass	1800 mm	680 mm

### Air Chair Massage

Chair massage in fiberglass construction is specially designed for spa center swimming pool. Sit and relax, enjoy neck massage, shoulder massage, back massage, leg massage and feet massage. Flow required : 27 m<sup>3</sup>/hr



#### Specifications

- Dimensions: 1100 x 780 mm
- Water massage jets: 17
- Feet massage: yes
- Shoulder massage: yes
- Hand twist spa system: yes
- Perfect therapy control center: yes

Code	Description	Dimensions	
		Length	Width
0159AC	Air Chair Massage Fiberglass	1100 mm	780 mm

# Wellness

## Stainless Steel Relaxation

### Wall Massage Nozzles

Made of AISI 316 with 2" threaded connection, 15 orifices of Ø3.5mm to provide quality massage. Provided with air venture for air-water mix massage. Available in two models: wall massage short nozzle and long type nozzle.



Code		Dimensions			Weight
Code		A	B	C	Kg
012991	Wall Massage Nozzle Short AISI 316	130 mm	120 mm	85 mm	1.15
012993	Wall Massage Nozzle Long AISI 316	410 mm	100 mm	165 mm	2.7

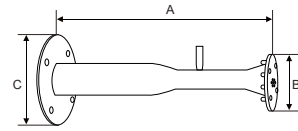
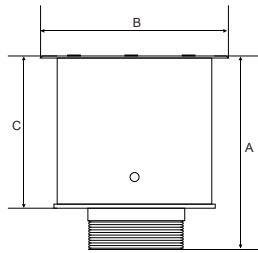

### Stainless Steel Relaxation

Projects by Atecpool



# Pool Bikes

## Athletics Swimming Pool Bikes

### Atecpool Inobike

The fixed dual resistance system (blades + pedals) make the Inobike the ideal bike for cardio exercises.

#### Specifications

- 100% marine stainless steel (AISI 316L)
- Brushed steel with corrosion protection treatment
- Non-modifiable resistance thanks to the AquaSpeed 2 pedal design
- Flexible, anatomical design, comfortable to sit on and easy to maintain
- Stainless steel ball bearings and sealing rings
- Ergonomic design with non-scratch handles
- Height and depth adjustments for handlebars and saddle in front of and behind overlaps
- Stainless steel ball bearings on white non-scratch wheels, easy movement
- White non-scratch stability pads
- Adapted to all coatings (liner, PVC, tiles, casing, polyester, etc.)
- Suitable for thermal water, seawater and chlorinated water
- Innovative click & turn system for a vertical position, prevents injury
- Min. dimensions: L 55cm x W 96cm x H 120cm
- Max. dimensions: L 55cm x W 120cm x H 164cm
- Depth 1.10m to 1.60m



Code	Description	Weight (kg)	Volume (m³)
012555	Atecpool Inobike	21	108

### Atecpool Fitpool

The Fitpool is an innovative self-supporting pool that can be easily dismantled, since it combines the simplicity of installation of a spa with aquafitness equipment: the Inobike. Special design for aquabiking. No bike is included\*.



#### Features

- Easy installation in 35 mins
- LED lighting
- Filtration pump
- Isothermal cover included
- Ladder included
- Dimension L. 184 x W. 184 x H. 127 cm

Code	Description	Volume (m³)
012666	Atecpool Fitpool	4.2

\*Atecpool Inobike is suitable for Atecpool Fitpool



**ATECPPOOL**

---

# CLEANING

---

# EQUIPMENT

---

